

Diritti riservati All rights reserved

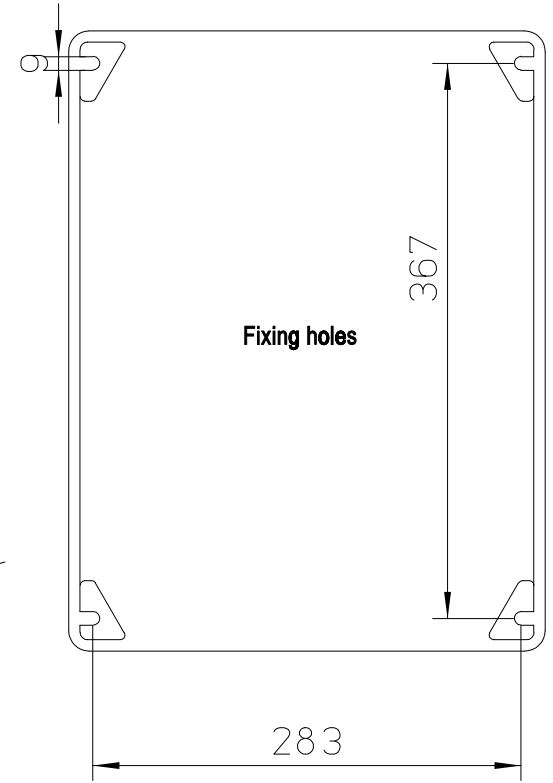

Sez. B-B

Sez. A-A

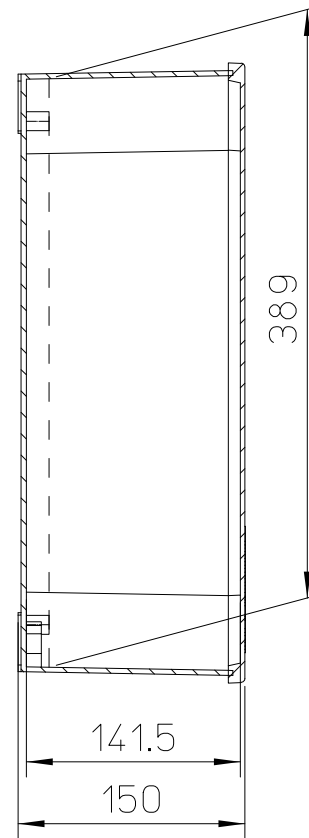
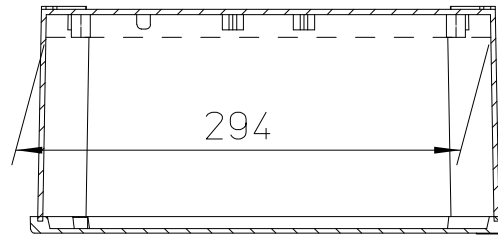
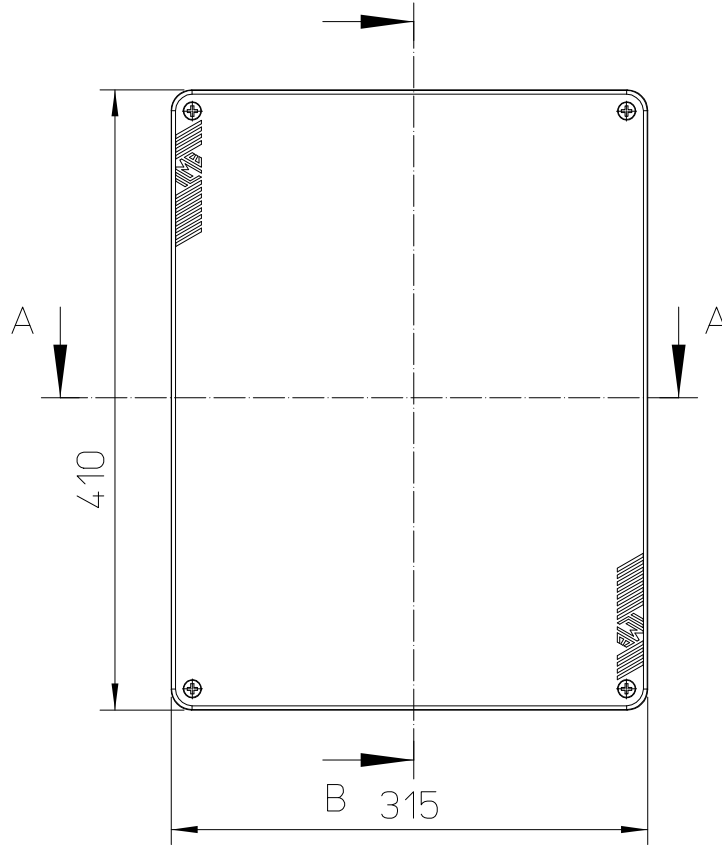
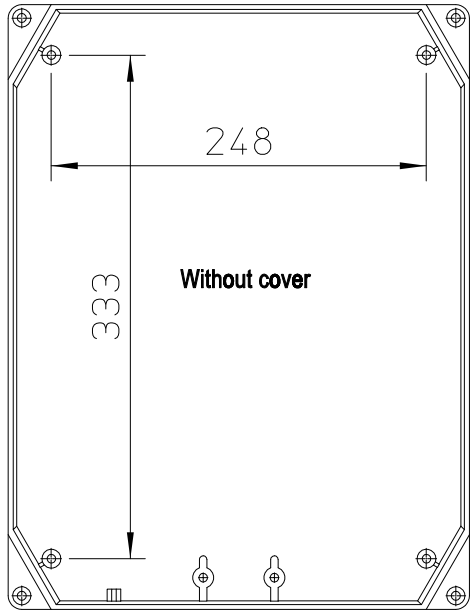
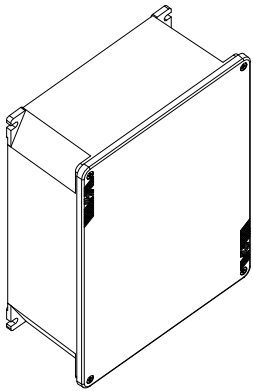

Scala 1:10

| | | | |
|------------------|-------------------------------|-------|---------------------------------------------------------------------------------------|
| | | | |
| | | | |
| | | | |
| | | | |
| | | | |
| | | | |
| dimensions in mm | APW 21 | Scale |  |
| Date 19/12/16 | Box 315 x 410 x 150 IP66/IP67 | 1:5 | |
| Sign. C. Mainini | | | |